

Electrical Features

Power supply voltage	12 to 24 Vdc (Polarity protection, overvoltage protection)
Input rated voltage	24 Vdc
Power consumption	20 W
Rated Power	20W
I max.	3.5 A

Physical Characteristics

Dimensions H x W x D	91 x 71 x 62 mm	
Weight	221 g without Expansion board	
Connector specifications	Communication connector	20 - 26 AWG push-in
	Power supply connector	16 - 28 AWG screw
DIN Rail	TS35, heat sink included	
IP grade protection	IP20	
Ambient humidity (operating)	10 % to 95 % (no condensation)	
Ambient environment (operating)	0 ° to 55°C with no corrosive gas	
Ambient temperature (storage)	0 ° to 60 °C	

Technical Features

Board	Original Raspberry Pi 4B	
CPU	Broadcom BCM2711, Quad core (ARM v8) 64-bit SoC	
Clock speed	1.8 GHz	
RAM	RAM	Reference
	2GB RPI	024002Y00101
	4GB RPI	024003Y00101
8GB RPI	024004Y00101	
Default OS	Debian Bookworm 64 bit (With custom configurations)	
microSD Card	Includes 20 GB SLC microSD card (Industrial Grade)	
UPS	Controlled by software to safely shutdown the Raspberry Pi when power failure	
RTC	PCF85363 Real Time Clock, powered with button battery (CR1216 or CR1220)	

Interface Features

RS-485	120Ω termination resistor (switchable)
I2C	5V, direct from Raspberry Pi board. Address 0x51 is in use
Ethernet	x1 Gbit Ethernet, RJ45 connector
USB	x2 USB-A 2.0, x2 USB-A 3.0



Overall device dimensions

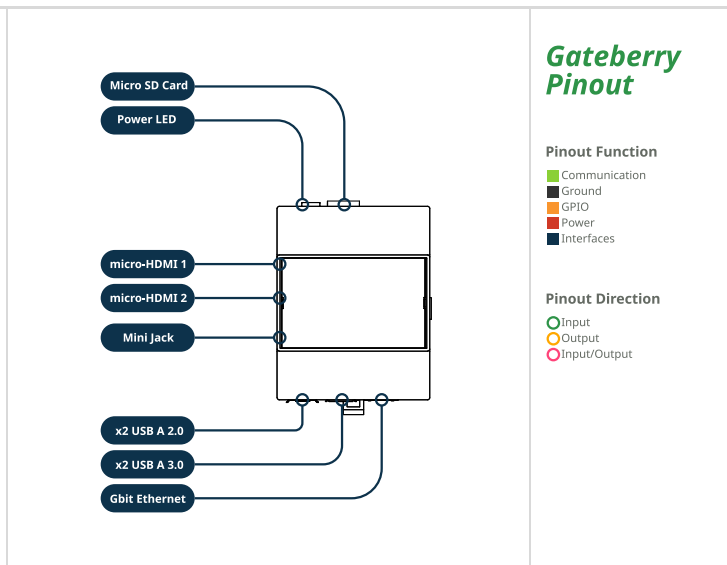
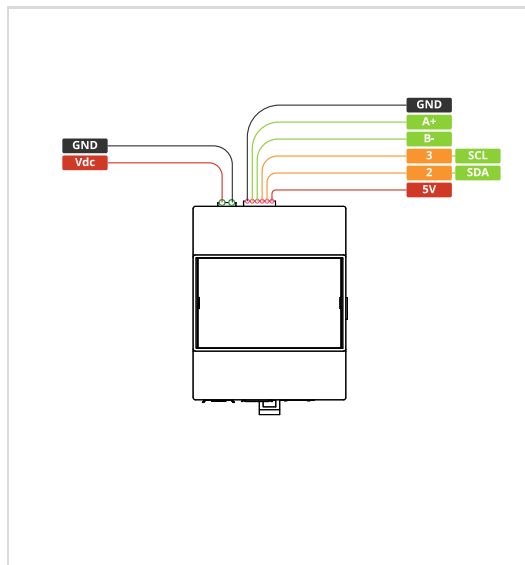
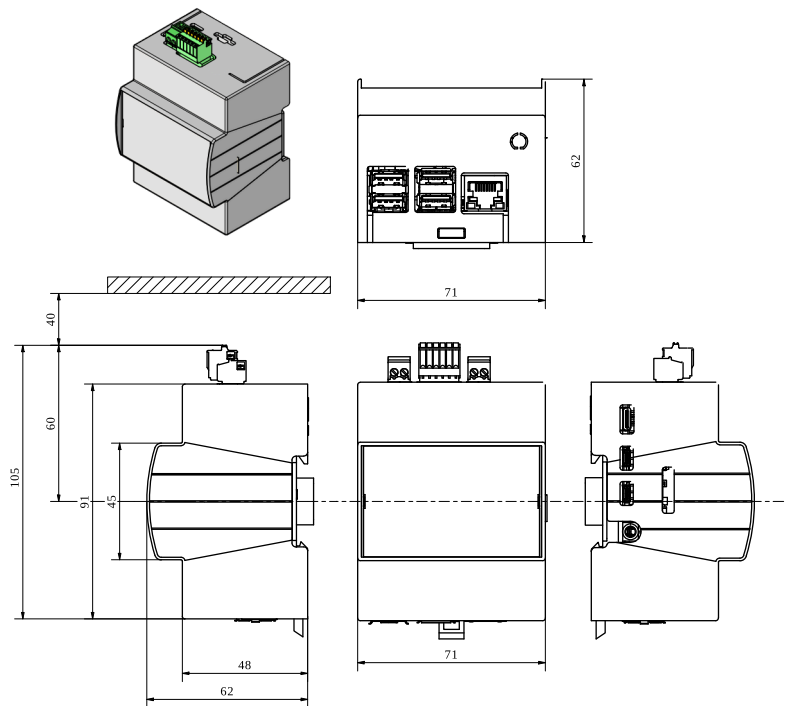

Raspberry Access

How to access to the Raspberry PLC with the default Gateberry image:

-Linux users: using ssh specifying the IP address: 10.10.10.20/24.

-Windows users: we recommend to use PuTTY ssh client. The IP address have to be specified: 10.10.10.20/24.

You can download the latest release of PuTTY here:

<https://www.chiark.greenend.org.uk/~sgtatham/putty/latest.html>

UPS Shield









This PLC has integrated an UPS Shield, a device which provides an anti-voltage drop protection system designed to avoid data corruption when the current is suddenly cut off.

Available Expansion Boards

Customize one additional communication expansion on your Gateberry.

LTE Cat 1 (02400X300101)	LTE Cat 4 (02400XD00101)
<ul style="list-style-type: none"> Model: SARA-R412M Type: 2G EGPRS, GSM/LTE. Key Features: GSM Quad-band 850/1900, 900/1800 MHz. Maximum output power -8dBm, IPv4/IPv6, dual-stack. 	<ul style="list-style-type: none"> Model: LARA-L6 Type: LTE Cat 4 (FDD/TDD) Key Features: Multi-band LTE (700-2600 MHz), 23 dBm output, 150 Mbps DL / 50 Mbps UL, GNSS (GPS/GLONASS), IPv4/IPv6 dual-stack.
GPS (02400X500101)	M-BUS Master / M-BUS Slave (02400XA00101)
<ul style="list-style-type: none"> Model: L80-M39 Type: GPS Module Key Features: L1 1575.42 MHz, 66 search / 22 tracking channels, up to 10 Hz update rate, 0.1 m/s velocity and 0.1 m/s² acceleration accuracy (no aid). 	<ul style="list-style-type: none"> Model: TSS721ADR Type: Power Line Communication (PLC) Transceiver. Key Features: Supports IEC 61334-5-1 standard, 1200-bps data rate over power lines, low-power operation.
LoRa (02400X200101 EU / Asia - 02400X600101 USA / AU)	CAN (02400X100101)
<ul style="list-style-type: none"> Model: RN2483 (EU/Asia), RN2903 (USA/AU) Type: LoRa Module Key Features: Integrated LoRaWAN stack, UART with ASCII command interface, DFU over UART, castellated SMT pads, RoHS compliant, etc. 	<ul style="list-style-type: none"> Model: MCP2515 Type: CAN V2.0B Key Features: Speed of 1Mb/s, receive buffers, masks and filters, data byte filtering on the first two data bytes, three transmit buffers with prioritization and abort features, high speed SPI interface (10MHz), etc.

Symbology

	Indicates that the equipment is suitable for direct current only; to identify relevant terminals
	Indicates that the equipment is suitable for alternating current only; to identify relevant terminals
	To identify the control by which a pulse is started.
	To identify an earth (ground) terminal in cases where neither the symbol 5018 nor 5019 is explicitly required.
	To identify the switch by means of which the signal lamp(s) is (are) switched on or off.
	CE marking indicates that a product complies with applicable European Union regulations
	Indicates a potentially hazardous situation which, if not avoided, could result in death or serious injury
	To indicate hazards arising from dangerous voltages

Warnings

Unused pins should not be connected. Ignoring the directive may damage the controller.

Before using this product, it is the responsibility of the user to read the product's User Guide and all accompanying documentation.

Industrial Shields PLCs must be powered between 12Vdc and 24Vdc. If a higher voltage is supplied to the equipment can suffer irreversible damage.

Maintenance must be performed by qualified personnel familiarized with the construction, operation, and hazards involved with the control.

Maintenance should be performed with the control out of operation and disconnected from all sources of power.

The Industrial Shields Family PLCs are Open Type Controllers. It is required that you install the Gateberry in a housing, cabinet, or electric control room. Entry to the housing, cabinet, or electric control room should be limited to authorized personnel.

Inside the housing, cabinet or electric control room, the Industrial Shields PLC must be at a minimum distance from the rest of the components of a minimum of 25 cm, it can be severely damaged.

Failure to follow these installation requirements could result in severe personal injury and/or property damage. Always follow these requirements when installing Gateberrys.

In case of installation or maintenance of the PLC please follow the instructions marked in the Installation and Maintenance section on the User Guide.

Do not disconnect equipment when a flammable or combustible atmosphere is present.

Disconnection of equipment when a flammable or combustible atmosphere is present may cause a fire or explosion which could result in death, serious injury and/or property damage.

Inside the encapsulated, there are supercapacitors if 25F which can be dangerous. Be careful with them.

This equipment does **not include galvanic isolation between the grounds** of the different systems. This means that if an external device or sensor that shares the same ground reference (GND) with the system is connected, any potential difference between these grounds could damage the connected components. To avoid issues with interference, ground loops, or damage to external equipment, ensure that all connected devices share the same ground reference or use systems with appropriate isolation. The recommendations in this case are:

- Connection Review:** Verify that all ground connections are properly made and that there are no significant potential differences between them.
- Use of Isolation:** Consider using **galvanic isolators** or **isolation transformers** if it is necessary to connect equipment with different ground references.

Technical Support

You can contact with us using the best channel for you:

 support@industrialshields.com

 www.industrialshields.com

 Visit our Blog, Forum or Ticketing system

 Use our chat service

 Check the user guides

 Visit our Channel

