

# Datasheet

# Raspberry PLC

# Ethernet CPU



Industrial Shields®

Technical Features **CONNECTABLE PLC RASPBERRY PI 24Vdc**

MODEL TYPE	Raspberry PLC
Input Voltage	12 to 24Vdc (Fuse protection (2.5A) Polarity protection)
Input rated voltage	24Vdc
Rated Power	30 W
I max.	1.5A
Size	101x70.1x119.5
SRAM	2/4/8 GB
Communications	I2C, Ethernet (x2), USB (x4), RS485 (x2), SPI, WiFi, Bluetooth, Serial TTL, CAN, microSD, RTC

General Features

Power supply voltage	DC power supply	12 to 24Vdc
Operating voltage range	DC power supply	11.4 to 25.4Vdc
Power consumption	DC power supply	30 W MAX.
External power supply	Power supply voltage	24Vdc
	Power supply current	700 mA
Insulation resistance	20mΩ min.at 500Vdc between the AC terminals and the protective earth terminal.	
Dielectric strength	2.300 VAC at 50/60 Hz for one minute with a leakage current of 10mA max. Between all the external AC terminals and the protective ground terminal.	
Shock resistance	80m/s2 in the X, Y and Z direction 2 times each.	
Ambient temperature (operating)	0° to 50°C with Raspberry OS Lite / 0° to 40°C with Raspberry OS Desktop	
Ambient humidity (operating)	10% to 90% (no condensation)	
Ambient environment (operating)	With no corrosive gas	
Ambient temperature (storage)	-20° to 60°C	
Power supply holding time	2ms min.	
Weight	378g max.	

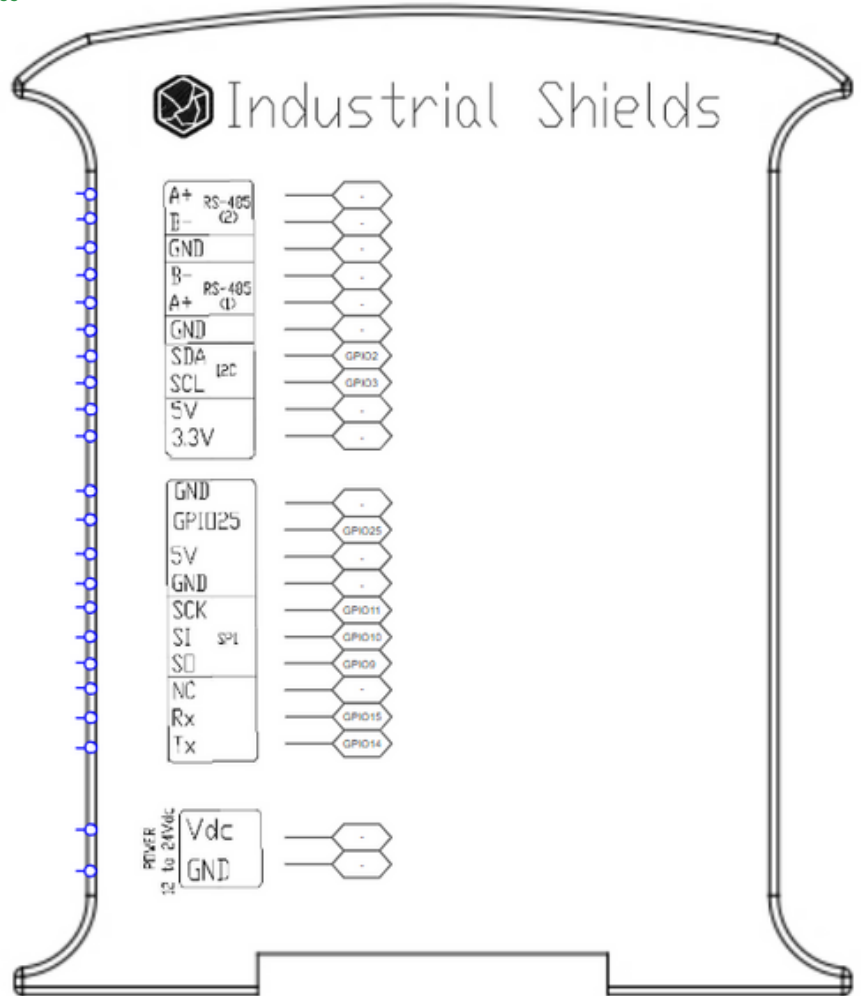

**i** GPIO(x1)

Digital GPIO25 (3.3V)

Expandability

I2C - 127 elements - Serial Port / RS485



Raspberry Pi

Pinout equivalence

Raspberry Pinout	PLC Pinout
NC	-
5V	-
GPIO2	SDA
5V	-
GPIO3	SCL
GND	-
GPIO4	INT31
GPIO14	TX
GND	-
GPIO15	RX
GPIO17	INT30
GPIO18	INT21
GPIO27	INT20
GND	-
GPIO22	IRQ SPI 485
GPIO23	UPS CONTROL FROM RASPI
NC	-
GPIO24	UPS CONTROL TO RASPI
GPIO10	MOSI 0
GND	-
GPIO9	MISO 0
GPIO25	GPIO25
GPIO11	SCLK 0
GPIO8	CS SPI0 CAN
GND	-
GPIO7	CS SPI0 ETH
GPIO 0	-
GPIO1	-
GPIO5	IRQ SPI CAN
GND	-
GPIO6	IRQ SPI ETH
GPIO12	INT11
GPIO13	INT10
GND	-
GPIO19	MISO 1
GPIO16	CS SPI1 485
GPIO26	FAN CONTROL
GPIO 20	MOSI 1
GND	-
GPIO21	SCLK 1

Internal Scheme

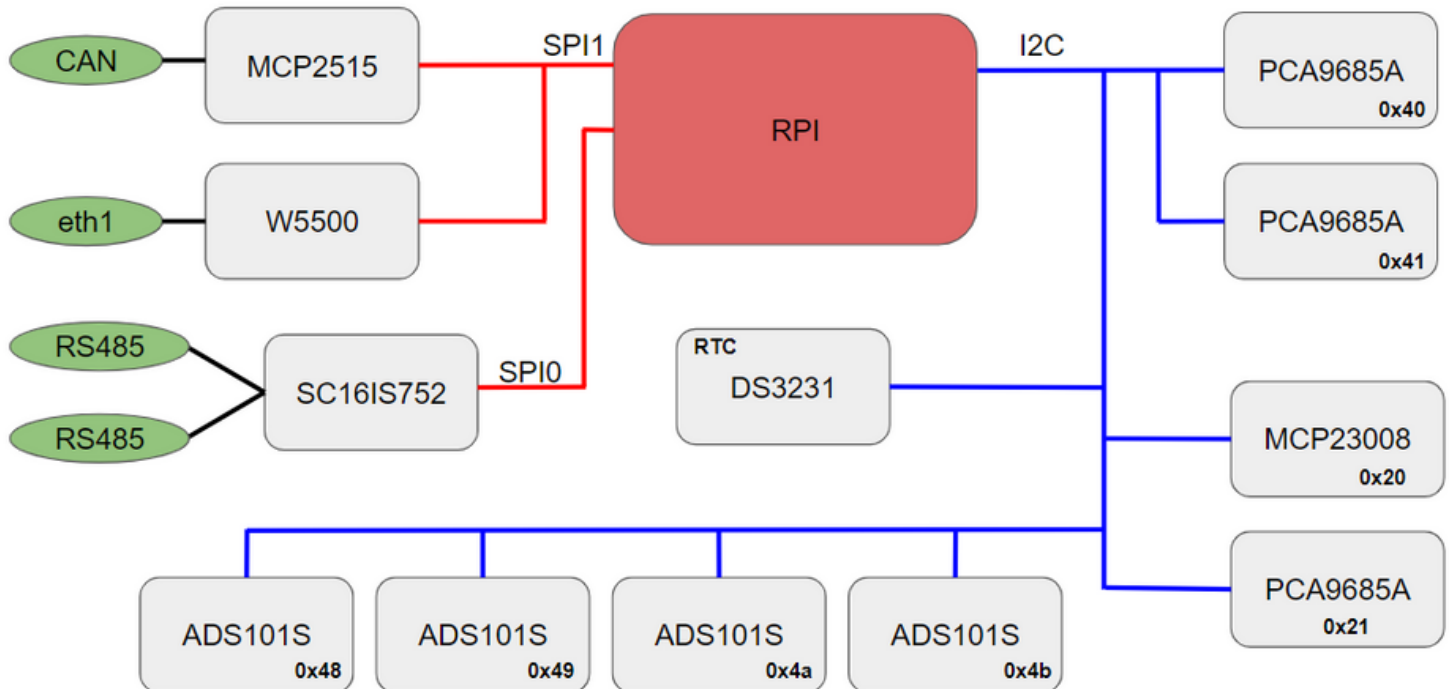

## Performance Specifications

Raspberry Board	Raspberry Pi 4
I/O control method	Combination of the cyclic scan and immediate refresh processing methods.
Programming language	Linux applications: Python, C++, etc.
CPU	Broadcom BCM2711, Quad core Cortex-A72 (ARM v8) 64-bit SoC @ 1.5GHz
Website	<a href="https://www.raspberrypi.org/">https://www.raspberrypi.org/</a>

### Raspberry PLC Access

How to access to the Raspberry PLC:

-Linux users: using ssh specifying the IP address: 10.10.10.20/24.

-Windows users: we recommend to use PuTTY ssh client. The IP address have to be specified: 10.10.10.20/24.

You can download the latest release of PuTTY here:

<https://www.chiark.greenend.org.uk/~sgtatham/putty/latest.html>

### UPS Shield

This PLC has integrated an UPS Shield, a device which provides an anti-voltage drop protection system designed to avoid data corruption when the current is suddenly cut off.

### RTC

This PLC has integrated the DS3231 Real Time Clock model which is powered by a button battery (CR1216 or CR1220).

### Fan

This PLC has the option to include a fan to refrigerate the CPU and the other components if the working environment requires it.

### Warnings



Unused pins should not be connected. Ignoring the directive may damage the controller.

Before using this product, it is the responsibility of the user to read the product's User Guide and all accompanying documentation.

Industrial Shields PLCs must be powered between 12Vdc and 24Vdc. If a higher voltage is supplied to the equipment can suffer irreversible damage.

Maintenance must be performed by qualified personnel familiarized with the construction, operation, and hazards involved with the control.

Maintenance should be performed with the control out of operation and disconnected from all sources of power.

The Industrial Shields Family PLCs are Open Type Controllers. It is required that you install the Raspberry PLC in a housing, cabinet, or electric control room. Entry to the housing, cabinet, or electric control room should be limited to authorized personnel.

Inside the housing, cabinet or electric control room, the Industrial Shields PLC must be at a minimum distance from the rest of the components of a minimum of 25 cm, it can be severely damaged.

Failure to follow these installation requirements could result in severe personal injury and/or property damage. Always follow these requirements when installing Raspberry family PLCs.









In case of installation or maintenance of the PLC please follow the instructions marked in the Installation and Maintenance section on the User Guide.

Do not disconnect equipment when a flammable or combustible atmosphere is present.

Disconnection of equipment when a flammable or combustible atmosphere is present may cause a fire or explosion which could result in death, serious injury and/or property damage.

Inside the encapsulated, there are supercapacitors if 25F which can be dangerous. Be careful with them.

### Symbology

	Indicates that the equipment is suitable for direct current only; to identify relevant terminals
	Indicates that the equipment is suitable for alternating current only; to identify relevant terminals
	To identify the control by which a pulse is started.
	To identify an earth (ground) terminal in cases where neither the symbol 5018 nor 5019 is explicitly required.
	To identify the switch by means of which the signal lamp(s) is (are) switched on or off.
	CE marking indicates that a product complies with applicable European Union regulations
	Indicates a potentially hazardous situation which, if not avoided, could result in death or serious injury
	To indicate hazards arising from dangerous voltages

### Technical Support

You can contact with us using the best channel for you:



[support@industrialshields.com](mailto:support@industrialshields.com)



[www.industrialshields.com](http://www.industrialshields.com)



Visit our Blog, Forum or Ticketing system



Use our chat service



Check the user guides



Visit our Channel

