

Datasheet

ESP32

PLC Family



Industrial Shields

Technical Features ESP32 Internal Chip

MODEL TYPE	ESP32-WROOM-32UE
Input Voltage	12 to 24Vdc (Fuse protection (2.5A) Polarity protection)
Input rated voltage	24Vdc
Rated Power	30 W
I max.	15A
Size	101x119.5x70.1 101x119.5x94.7 101x119.5x119.3
SRAM	520 KB
Communications & Accessories	I2C, Ethernet, SPI, RS485 (Half Duplex), RS232, microSD, RTC, Bluetooth V4.2 BR/EDR and Bluetooth LE, Wi-Fi 802.11b/g/n, SerialTTL, VN/VP

General Features

Power supply voltage	DC power supply	12 to 24Vdc
Operating voltage range	DC power supply	11.4 to 25.4Vdc
Power consumption	DC power supply	30 W MAX.
External power supply	Power supply voltage	24Vdc
	Power supply voltage	700 mA
Insulation resistance	20mΩ min.at 500Vdc between the AC terminals and the protective earth terminal.	
Dielectric strength	2.300 VAC at 50/60 Hz for one minute with a leakage current of 10mA max. Between all the external AC terminals and the protective ground terminal.	
Shock resistance	80m/s ² in the X, Y and Z direction 2 times each.	
Ambient temperature (operating)	-20° to 60°C	
Ambient humidity (operating)	10% to 90% (no condensation)	
Ambient environment (operating)	With no corrosive gas	
Ambient temperature (storage)	-20° to 60°C	
Power supply holding time	2ms min.	
Weight	380g/490g/600g	

GPIO(x1)

Digital GPIO 0 (3.3V)

Expandability

I2C - 127 elements
ModbusRTU with RS485: 32 elements

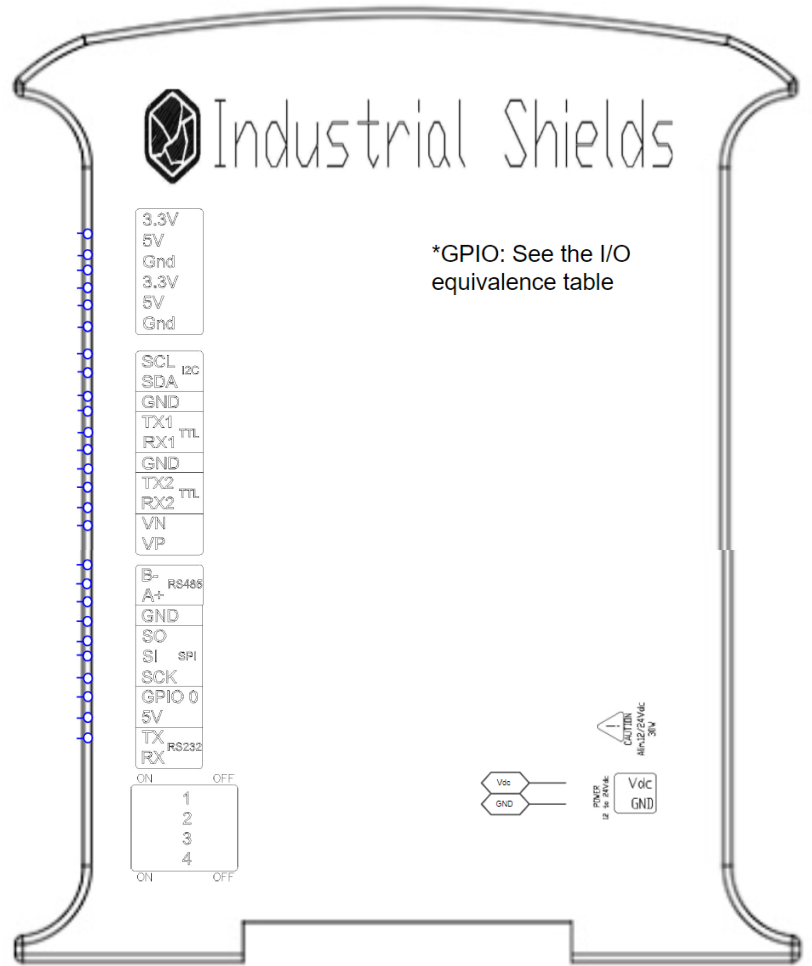

Upper Side

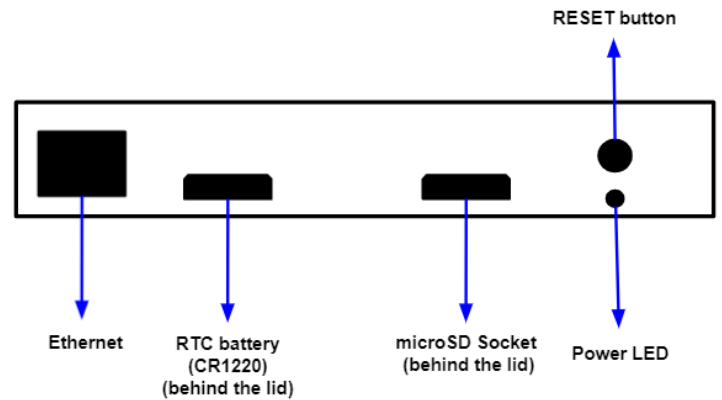

Peripheral ports - USB & SIM Card Slot & Antennas

- The microUSB type B port for programming is located at the right side of the PLC enclosure
- The SIM Card Slot is also located at the right side of the PLC enclosure
- Additional Wi-Fi Antenna with SMA female connector (on the frontal top side) included on the PLC
- Expansion Board Antenna (if required) with SMA female connector (on the frontal top side) included on the PLC

I/Os Table

		I/Os Table				
Model	Reference	Analog Input	Digital Isolated Input	Digital Isolated Output	Digital/Analogic Output	Relay Output
21+	01200X000200	6	7	5	3	0
42+	01200X000400	12	14	10	6	0
58+	01200X000600	16	21	15	9	0
19R	01200X000100	4	2	0	3	8
38R	01200X000300	8	4	0	6	16
57R	01200X000500	12	8	0	9	24
38AR	01200X000700	10	9	5	6	8
57AAR	01200X000800	16	16	10	9	8
50RRA	01200X000900	12	11	5	9	16
53ARR	01200X001000	14	11	5	9	16
54ARA	01200X001100	14	16	10	9	8

Reference Table

		Zones Table			
Model		Zone 0	Zone A	Zone B	Zone C
ESP32 PLC 21+		✓	Analog / Digital	-	-
ESP32 PLC 42+		✓	Analog / Digital	Analog / Digital	-
ESP32 PLC 58+		✓	Analog / Digital	Analog / Digital	Analog / Digital
ESP32 PLC 19R+		✓	Relay	-	-
ESP32 PLC 38R+		✓	Relay	Relay	-
ESP32 PLC 57R+		✓	Relay	Relay	Relay
ESP32 PLC 38AR+		✓	Analog / Digital	Relay	-
ESP32 PLC 53ARR+		✓	Analog / Digital	Relay	Relay
ESP32 PLC 57AAR+		✓	Analog / Digital	Analog / Digital	Relay
ESP32 PLC 54ARA+		✓	Analog / Digital	Relay	Analog / Digital
ESP32 PLC 50RRA+		✓	Relay	Relay	Analog / Digital

I/Os Ranges

- Analogic Inputs voltage: 0 - 10 Vdc (Imin = 2 to 12 mA) | Analogic Outputs Voltage: 0 - 10 Vdc (Imax = 20 mA)
- Digital Inputs voltage: 5 - 24 Vdc (Imin = 2 to 12 mA) | Digital Outputs voltage: 5 - 24 Vdc (Imax = 70 mA)
- Relay's voltage: 30 Vdc (3A) | 220 Vac (5 A)

Internal Scheme

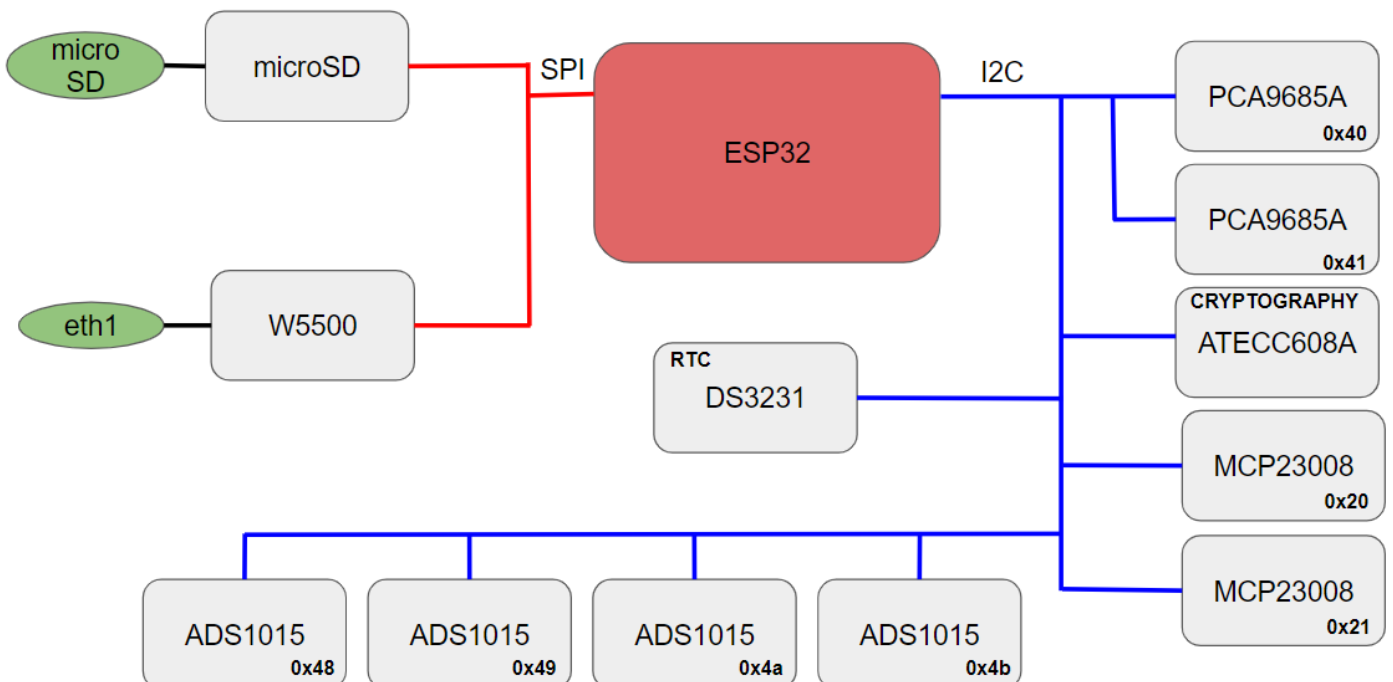

Analog I/Os equivalence

Analog Inputs		
PLC Pinout	Chip ADDR	Chip INDEX
Zone A		
I0.7	0x49	2
I0.8	0x49	3
I0.9	0x48	3
I0.10	0x48	2
I0.11	0x48	1
I0.12	0x48	0
Zone B		
I1.7	0x49	0
I1.8	0x49	1
I1.9	0x4a	3
I1.10	0x4a	2
I1.11	0x4a	0
I1.12	0x4a	1
Zone C		
I2.7	0x4b	3
I2.8	0x4b	2
I2.9	0x4b	0
I2.10	0x4b	1

Analog Outputs		
PLC Pinout	Chip ADDR	Chip INDEX
Zone A		
A0.5	0x40	13
A0.6	0x40	6
A0.7	0x40	7
Zone B		
A1.5	0x40	3
A1.6	0x41	8
A1.7	0x41	9
Zone C		
A2.5	0x41	10
A2.6	0x41	6
A2.7	0x41	7

Digital Inputs			
PLC Pinout	Chip ADDR	Chip INDEX	GPIO
Zone A			
I0.0	ADDR = 0x21	6	-
I0.1	ADDR = 0x21	4	-
I0.2	ADDR = 0x21	5	-
I0.3	ADDR = 0x21	3	-
I0.4	ADDR = 0x21	2	-
I0.5	-	-	GPIO = 27
I0.6	-	-	GPIO = 26
Zone B			
I1.0	ADDR = 0x21	1	-
I1.1	ADDR = 0x21	0	-
I1.2	ADDR = 0x20	7	-
I1.3	ADDR = 0x20	6	-
I1.4	ADDR = 0x20	5	-
I1.5	-	-	GPIO = 35
I1.6	-	-	GPIO = 25
Zone C			
I2.0	ADDR = 0x20	4	-
I2.1	ADDR = 0x20	3	-
I2.2	ADDR = 0x20	2	-
I2.3	ADDR = 0x20	1	-
I2.4	ADDR = 0x20	0	-
I2.5	-	-	GPIO = 34
I2.6	-	-	GPIO = 5

Digital Outputs		
PLC Pinout	Chip ADDR	Chip INDEX
Zone A		
Q0.0	0x40	11
Q0.1	0x40	10
Q0.2	0x40	9
Q0.3	0x40	8
Q0.4	0x40	12
Q0.5	0x40	13
Q0.6	0x40	6
Q0.7	0x40	7
Zone B		
Q1.0	0x40	15
Q1.1	0x40	14
Q1.2	0x40	0
Q1.3	0x40	1
Q1.4	0x40	2
Q1.5	0x40	3
Q1.6	0x41	8
Q1.7	0x41	9
Zone C		
Q2.0	0x41	15
Q2.1	0x41	14
Q2.2	0x41	13
Q2.3	0x41	12
Q2.4	0x41	11
Q2.5	0x41	10
Q2.6	0x41	6
Q2.7	0x41	7

Relé I/Os equivalence

Analog Inputs		
PLC Pinout	Chip ADDR	Chip INDEX
Zone A		
I0.2	0x49	2
I0.3	0x49	3
I0.4	0x48	3
I0.5	0x48	2
Zone B		
I1.2	0x49	0
I1.3	0x49	1
I1.4	0x4a	3
I1.5	0x4a	2
Zone C		
I2.2	0x4b	3
I2.3	0x4b	2
I2.4	0x4b	0
I2.5	0x4b	1

Analog Outputs		
PLC Pinout	Chip ADDR	Chip INDEX
Zone A		
A0.0	0x40	0D
A0.1	0x40	6
A0.2	0x40	7
Zone B		
A1.0	0x40	3
A1.1	0x41	8
A1.2	0x41	9
Zone C		
A2.0	0x41	0A
A2.1	0x41	6
A2.2	0x41	7

Digital Inputs	
PLC Pinout	GPIO
Zone A	
I0.0	27
I0.1	26
Zone B	
I1.0	35
I1.1	25
Zone C	
I2.0	34
I2.1	5

Digital Outputs		
PLC Pinout	Chip ADDR	Chip INDEX
Zone A		
Q0.0	0x40	0D
Q0.1	0x40	6
Q0.2	0x40	7
Zone B		
Q1.0	0x40	3
Q1.1	0x41	8
Q1.2	0x41	9
Zone C		
Q2.0	0x41	0A
Q2.1	0x41	6
Q2.2	0x41	7

Relay I/Os equivalence

Relay		
PLC Pinout	Chip ADDR	Chip INDEX
Zone A		
R0.1	0x21	4
R0.2	0x21	6
R0.3	0x21	3
R0.4	0x21	5
R0.5	0x40	0C
R0.6	0x40	8
R0.7	0x40	9
R0.8	0x40	0A
Zone B		
R1.1	0x21	0
R1.2	0x21	1
R1.3	0x20	6
R1.4	0x20	7
R1.5	0x40	2
R1.6	0x40	1
R1.7	0x40	0
R1.8	0x40	0E
Zone C		
R2.1	0x20	3
R2.2	0x20	4
R2.3	0x20	1
R2.4	0x20	2
R2.5	0x41	0B
R2.6	0x41	0C
R2.7	0x41	0D
R2.8	0x41	0E

Performance Specifications

Raspberry Board	ESP32-WROOM-32UE
I/O control method	Combination of the cyclic scan and immediate refresh processing methods.
Programming language	Arduino IDE
Website	https://www.espressif.com/

Communication Switch mapping

SWICH CONFIGURATION				
	1	2	3	4
RS485	X	X	OFF	X
TX1/RX1	X	X	ON	X
RS232	X	OFF	X	X
TX2/RX2	X	ON	X	X
EXP 2	X	ON	X	ON

RTC

This PLC has integrated the DS3231 Real Time Clock model which is powered by a button battery (CR1216 or CR1220).

Warnings

Unused pins should not be connected. Ignoring the directive may damage the controller.

Before using this product, it is the responsibility of the user to read the product's User Guide and all accompanying documentation.

Industrial Shields PLCs must be powered between 12Vdc and 24Vdc. If a higher voltage is supplied to the equipment can suffer irreversible damage.

Maintenance must be performed by qualified personnel familiarized with the construction, operation, and hazards involved with the control.

Maintenance should be performed with the control out of operation and disconnected from all sources of power.

The Industrial Shields Family PLCs are Open Type Controllers. It is required that you install the Raspberry PLC in a housing, cabinet, or electric control room. Entry to the housing, cabinet, or electric control room should be limited to authorized personnel.

Inside the housing, cabinet or electric control room, the Industrial Shields PLC must be at a minimum distance from the rest of the components of a minimum of 25 cm, it can be severely damaged.

Failure to follow these installation requirements could result in severe personal injury and/or property damage. Always follow these requirements when installing Raspberry family PLCs.









In case of installation or maintenance of the PLC please follow the instructions marked in the Installation and Maintenance section on the User Guide.

Do not disconnect equipment when a flammable or combustible atmosphere is present.

Disconnection of equipment when a flammable or combustible atmosphere is present may cause a fire or explosion which could result in death, serious injury and/or property damage.

Inside the encapsulated, there are supercapacitors if 25F which can be dangerous. Be careful with them.

Symbology

	Indicates that the equipment is suitable for direct current only; to identify relevant terminals
	Indicates that the equipment is suitable for alternating current only; to identify relevant terminals
	To identify the control by which a pulse is started.
	To identify an earth (ground) terminal in cases where neither the symbol 5018 nor 5019 is explicitly required.
	To identify the switch by means of which the signal lamp(s) is (are) switched on or off.
	CE marking indicates that a product complies with applicable European Union regulations
	Indicates a potentially hazardous situation which, if not avoided, could result in death or serious injury
	To indicate hazards arising from dangerous voltages

Technical Support

You can contact with us using the best channel for you:

 support@industrialshields.com

 www.industrialshields.com

 Visit our Blog, Forum or Ticketing system

 34 644 927 900

 Use our chat service

 Check the user guides

 Visit our Channel

