



INDUSTRIAL SHIELDS

Raspberry Pi UPS & RTC Shield



- Plug & Play UPS Smart Shield and Real Time Clock (RTC) for Raspberry Pi
- Avoid any SD corruption issue
- 12Vdc or 24Vdc
- With RS485 protocol available
- Compatible with Tinkerboard. All Raspberry Pi 2, 3, 4 & all Raspberry Pi B models
- Recharge Time: Less than 1 minute
- Reconnecting time: Less than 20 seconds
- With reboot button (or the possibility to add an external one)

Raspberry Pi UPS & RTC Shield

Revised April 2020

Preface

This User Guide is been implemented by Boot & Work, S.L. working under the name Industrial Shields.

Purpose of the manual

The information contained in this manual can be used as a reference to operating, to functions, and to the technical data of the signal modules, power supply modules and interface modules.

Intended Audience

This User Guide is intended for the following audience:

- Persons in charge of introducing automation devices.
- Persons who design automation systems.
- Persons who install or connect automation devices.
- Persons who manage working automation installation.

Intended use or of Industrial Shields products

Consider the following:

Industrial Shields products should only be used for the cases of application foreseen in the catalogue and the associated technical documentation. If third-party products and components are used, they must have been recommended or approved by Industrial Shields.

The correct and safe operation of the products requires that your transport, storage, installation, assembly, operation and maintenance have been carried out in a correct It must respect the permissible ambient conditions. You should also follow the indications and warnings that appear in the associated documentation.

The product / system dealt with in this documentation should only be handled or manipulated by qualified personnel for the task entrusted and observing what is indicated in the documentation corresponding to it, particularly the safety instructions and warnings included in it. Due to their training and experience, qualified personnel are in a position to recognize risks resulting from the handling or manipulation of such products / systems and to avoid possible hazards.

Disclaimers

Weights and Dimensions

Dimensions and weights are nominal and they are not used for manufacturing purposes, even when tolerances are shown.

Performance Data

The performance data given in this manual is provided as a guide for the user in determining suitability and does not constitute a warranty. It may represent the result of INDUSTRIAL SHIELDS's test conditions, and the users must correlate it to actual application requirements. Actual performance is subject to the INDUSTRIAL SHIELDS Warranty and Limitations of Liability.

Change in Specifications

Product specifications and accessories may be changed at any time based on improvements and other reasons.

It is our practice to change model numbers when features are changed, or published ratings or when significant construction changes are made. However, some specifications of the products may be changed without any notice. When in doubt, special numbers may be assigned to fix or establish key specifications for your

application on your request. Please consult with your INDUSTRIAL SHIELDS representative at any time to confirm actual specifications of purchased products.

Errors and Omissions

The information in this document has been carefully checked and is believed to be accurate; however, no responsibility is assumed for clerical, typographical, or proofreading errors, or omissions.

These components may only be operated in closed housings or in higher-level control cabinets with protective covers that are closed, and when all of the protective devices are used. These components may only be handled by qualified and trained technical personnel who are knowledgeable and observe all of the safety information and instructions on the components and in the associated technical user documentation. When carrying out a risk assessment of a machine in accordance with the EU Machinery Directive, the machine manufacturer must consider the following residual risks associated with the control and drive components of a PDS.

Table of Contents

1	General Description	5
1.1.	General Specifications.....	5
1.2.	Available Communications & Accessories.....	5
1.3.	UPS & RTC Shield Pinout	6
1.4.	Mechanical dimension	7
1.5.	Main parameters.....	7
1.6.	Raspberry Pi 3 Pinout Connector	8
1.7.	Raspberry Pi Connections:	10
1.8.	Connectors:	11
2.	Raspberry Pi Connections.....	13
2.1.	Enable the controlled shutdown on your Raspberry Pi	13
2.2.	Enable the RTC functionality on your Raspberry Pi.....	14
2.3.	Enable the RS-485 functionality on your Raspberry Pi.....	14



1 General Description

1.1. General Specifications

Operational Voltage	Current	Max. Current	Super Capacitors	Certificate	Possible MCU Connections	RTC
12 or 24Vdc (Antipolarity + Filter)	3 A (Autoprotected by chip)	3,5 A	x2 (25F)	CE, RoHs	-Raspberry Pi 2 & 2B -Raspberry Pi 3 & 3B -Raspberry Pi 4B -Tinkerboard (ASUS)	DS3231 Coin cell : CR2032

1.2. Available Communications & Accessories

- RS-485 Port
- ICSP Connector
- I2C (3,3Vdc)
- USB Type-C (Power Only)
- RTC
- Raspberry Pi Connectors
- Possibility of connecting a 5Vdc fan

1.3. UPS & RTC Shield Pinout

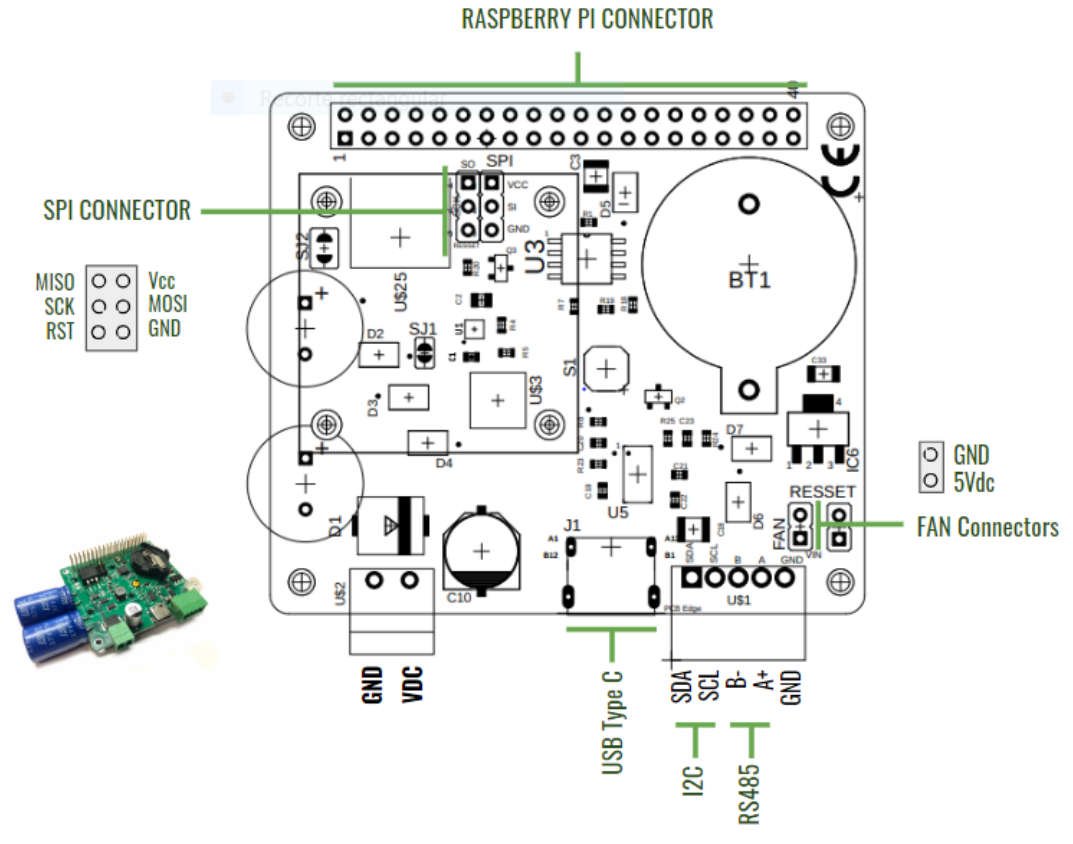

1.4. Mechanical dimension



1.5. Main parameters

Parameter	Value	Conditions
Input parameters		
Input voltage (screw terminal)	7V DC ... 28V DC	At screw terminal
Input voltage (USB terminal)	5V DC	USB terminal
Average input current	0.5A	Charge mode + RPi3 Booting at Vin = 24V
Output parameters		
Output voltage range	4.75V DC ... 5.5V DC	
Output current range	0Aavg ... 2Aavg	
Output ripple	20mV pp	Raspberry Pi4 as a web server
Fan voltage	4.75V – 5.5V DC	
Control parameters		
Pin 16 (GPIO23)	3.3V – 5V (Inputs maximum voltage)	
Pin 13 (GPIO27)	3.3V – 5V (Outputs maximum voltage)	

1.6. Raspberry PI 3 Pinout Connector

	NC	1	2	Vin	
SDA	GPI02	3	4	Vin	
SCL	GPI03	5	6	GND	
	NC	7	8	GPI014	TXD
	GND	9	10	GPI015	RXD
RE	GPI017	11	12	NC	
DE	GPI027	13	14	GND	
	NC	15	16	GPI023	UPS Control from RASPBERRY
	NC	17	18	GPI024	UPS Control to RASPBERRY
	NC	19	20	GND	
	NC	21	22	NC	
	NC	23	24	NC	
	GND	25	26	NC	
	NC	27	28	NC	
	NC	29	30	GND	
	NC	31	32	NC	
	NC	33	34	GND	
	NC	35	36	NC	
	NC	37	38	NC	
	GND	39	40	NC	

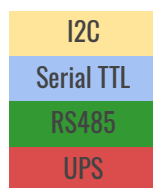

- GPIO24 (Raspberry's 18 pin) is used by UPS to report if an emergency power-off is needed. If the UPS shield detects that the external power supply has been lost, this pin is going to be connected to GND. In the opposite case, this pin is not going to be connected. Because of this, it is recommended to configure this pin with a pull-up software.
- GPIO23 (Raspberry's 16 pin) is used to report a finished saving process. If system fails, the UPS shield will maintain the power supply till it receives a low logic value from this pin. If

this pin is not connected, the UPS shield will manage that, in the case of a failure, it must provide power till the capacitors run out of energy.

- GPIO27 (Raspberry's 13 pin) is the 485 half duplex control. The transmission will be enabled with a positive logical value. The reception will be enabled with a negative logical value.
- **CAUTION:** this shield is used to discharge the capacitors but, when they are fully charged, it is very important to ensure that any short-circuit happens because it may brake the shield.
- The reset white connector it must have a normally open push button and, when it is pushed, the power supply is going to be removed from the Raspberry. This job can be equally done pushing the reset button in the shield.
- Just below the shield, there is a connector to provide power to a fan (if it is needed). There are through-holes to put support columns and a fan.

NOTE: If using Raspberry Pi 2 or Raspberry Pi 2 model B, consider the following information:

- GPIO27 is GPIO2 on a Raspberry Pi 2 or Raspberry Pi 2 B model.
- GPIO2 & GPIO3 are GPIO8 & GPIO9 respectively on a Raspberry Pi 2 or Raspberry Pi 2 B model.
- GPIO23 & GPIO24 are GPIO4 & GPIO5, respectively on a Raspberry Pi 2 or Raspberry Pi 2 B model.

1.7. Raspberry Pi Connections:

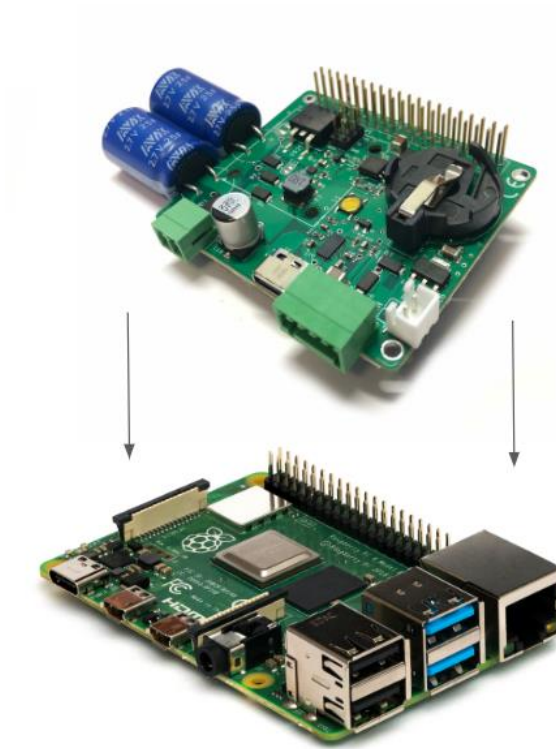

1.8. Connectors:

- POWER CONNECTOR:

SKU: 15EDGRC-3.81-02P-14-00A(H)

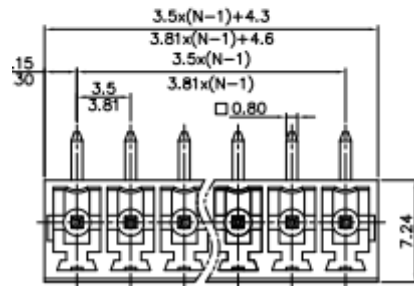
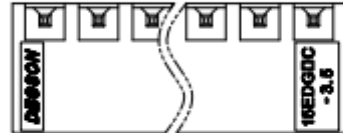

- COMMUNICATIONS CONNECTOR:

SKU: 15EDGKD-2.5-XXP-1Y-00A(H)

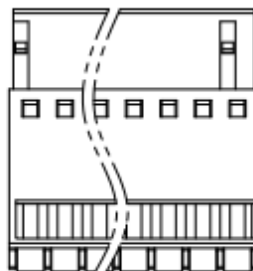
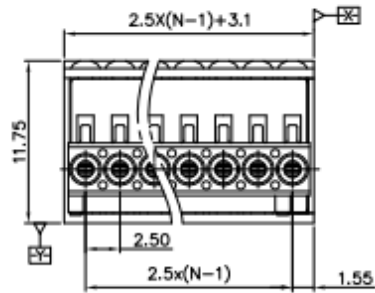
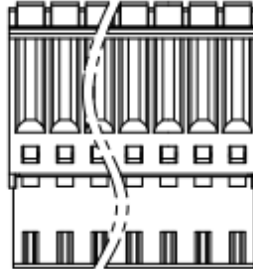

- RESET CONNECTOR:

SKU: B2B-XH-A (LF)(SN)



Shape A

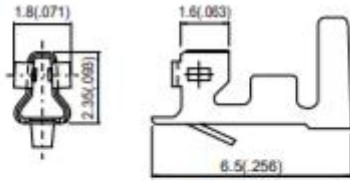

Shape B

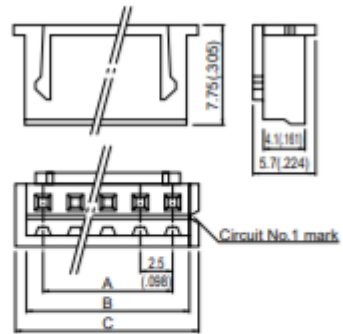
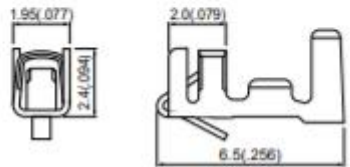

**Plugged up
(2 circuits 10.0mm(.394") pitch)**

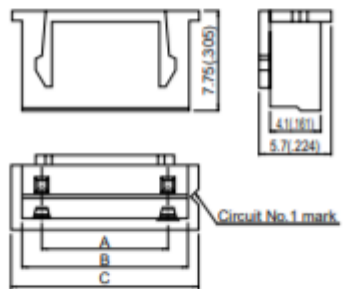

(6 circuits 5.0mm(.197") pitch)

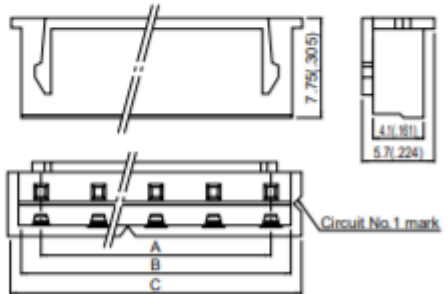

2. Raspberry Pi Connections

To start working with the UPS on your Raspberry Pi module, you need to download the `rpishutdown` file and `rpishutdown.service` provided on this [link](#).

2.1. Enable the controlled shutdown on your Raspberry Pi

`Rpishutdown` service allows the UPS to do a controlled shutdown of the Operative System once it detects that the main power inlet of the Raspberry PLC has been disabled. Then it closes all the opened processes before the shutdown, protecting the SD card image and all the files included.

Once both files are downloaded, the next step is copy this files on the expected folders:

We are going to copy to

```
/usr/local/bin/
```

the `rpishutdown` file. This file is usually created by default but, in case that it is not created, you can directly create this folder going to execute this command:

```
sudo mkdir -p /usr/local/bin/
```

Once we are on the expected folder, we are going to execute these commands in the following command:

```
cd /usr/local/bin
```

```
sudo chmod ugo+x rpishutdown
```

Now that the `rpishutdown` file has permissions, the next step is to copy the `rpishutdown.service` on the expected folder using the following command:

```
mv rpishutdown.service /lib/systemd/system
```

Finally, the service needs to be activated to run on the Operative System, this can be achieved with the next command:

```
sudo systemctl start rpishutdown.service
```

The service can be also stopped if needed:

```
sudo systemctl stop rpishutdown.service
```

2.2. Enable the RTC functionality on your Raspberry Pi

To enable the RTC functionalities, the steps to follow are:

- In order to ensure you have got the latest updates you should run the following commands:

```
sudo apt-get update
```

```
sudo apt-get -y upgrade
```

- In the file */boot/config.txt* uncomment the line

```
dtparam=i2c_arm=on
```

and at the end of the file */boot/config.txt*, after the `[all]` statement introduce the following line:

```
dtoverlay=i2c-rtc,sd3231
```

Finally, the last step requires to restart the Raspberry Pi so that the changes made are saved and you can work with the RTC integrated in the UPS.

2.3. Enable the RS-485 functionality on your Raspberry Pi

The UPS Shield module contains a 2-wire RS-485 (or RS-422) transceiver. The transceiver is driven by the Raspberry Pi UART interface on the GPIO14 and GPIO15 pins. We send and receive data by */dev/ttyS0*.

- In order to ensure you have got the latest updates you should run the following commands:

```
sudo apt-get update
```

```
sudo apt-get -y upgrade
```

and at the end of the file */boot/config.txt*, after the `[all]` statement introduce the following line:

```
enable_uart=1
```

- The following table includes the RS-485 port requirements:

Parameter	Value	Conditions
<i>RS-485 Interface Communication Type</i>	2-wire, half duplex	Transceiver chip ISL8483E
<i>RX/TX direction control</i>	Automatic Controlled by GPIO24	Diver enabled by a low TX data bit Driver disabled 25 us after the end of a low TX data bit Optional
<i>Failsafe biasing</i>	390R to GND 390R to 5V	
<i>Line Termination</i>	120R	390R//220R//390R+2*10R
<i>Protection</i>	ESD to +/- 15 kV	No Surge/Burst protection
<i>Echo-feature</i>	RX always enabled TX enabled at data	Optional
<i>Data transmission speed</i>	0...250kbps	25 us transmission pause between TX and RX required

About Industrial Shields:

Direction: Fàbrica del Pont, 1-11

Zip/Postal Code: 08272

City: Sant Fruitós de Bages (Barcelona)

Country: Spain

Telephone: (+34) 938 760 191 / (+34) 635 693 611

Mail: industrialshields@industrialshields.com